

## Data Sheet | Item Number: 2773-405

COMPACT splicing connector; for solid and stranded conductors; max. 4 mm<sup>2</sup>; 5-conductor; transparent housing; yellow cover; Surrounding air temperature: max 85°C (T85); 4,00 mm<sup>2</sup>; transparent

<https://www.wago.com/2773-405>

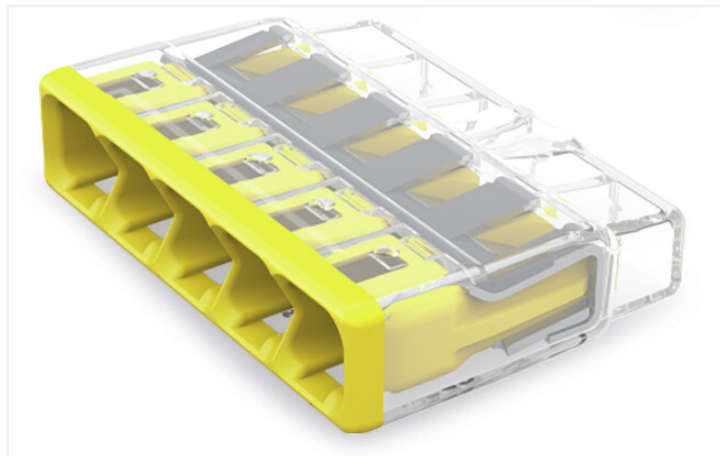

Color:  transparent

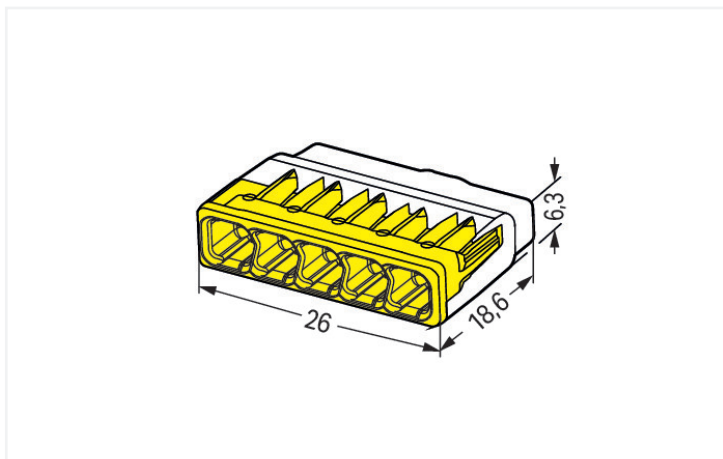

Dimensions in mm

### Advantages:

- Convenient wiring via extremely compact design
- Push-in termination of up to eight solid and stranded conductors
- Conductor range: 0.75 ... 4 mm<sup>2</sup> "s" and 1.5 ... 4 mm<sup>2</sup> "st"
- Any combination of conductor sizes is possible
- PUSH WIRE® connection terminates solid ("s+str") copper conductors

### Electrical data

Ratings per	IEC/EN 60998		
Overvoltage category	III	III	II
Pollution degree	3	2	2
Nominal voltage	-	-	450 V
Rated surge voltage	-	-	4 kV
Rated current	-	-	32 A

Approvals per	UL 486C		
Use group	B	C	D
Rated voltage	-	600 V	-
Rated current	-	20 A	-

## Connection data

Connection points	5
Total number of potentials	1

### Connection 1

Connection technology	PUSH WIRE®
Actuation type	Push-in
Connectable conductor materials	Copper
Solid conductor	0.75 ... 4 mm <sup>2</sup> / 20 ... 12 AWG
Stranded conductor	1.5 ... 4 mm <sup>2</sup> / 18 ... 12 AWG
Conductor diameter	1.6 ... 2 mm / 20 ... 12 AWG
Strip length	13 mm / 0.51 inches
Wiring direction	Side-entry wiring

## Physical data

Width	26 mm / 1.024 inches
Height	6.3 mm / 0.248 inches
Depth	18.6 mm / 0.732 inches

## Material data

Note (material data)	<a href="#">Information on material specifications can be found here</a>
Color	transparent
Cover color	yellow
Material group	IIIa
Insulation material	Polycarbonate (PC)
Flammability class per UL94	V2
Fire load	0.02 MJ
Weight	2.6 g

## Environmental requirements

Ambient temperature (operation)	+85 °C
Processing temperature	-35 ... +60 °C
Continuous operating temperature	-40 ... +105 °C
Temperature marking per EN 60998	T85

## Commercial data

ETIM 8.0	EC000446
ETIM 7.0	EC000446
PU (SPU)	600 (60) pcs
Packaging type	Box
Country of origin	DE
GTIN	4055143919241
Customs tariff number	85369010000

**Environmental Product Compliance**

RoHS Compliance Status	Compliant, No Exemption
------------------------	-------------------------

**Approvals / Certificates**

**General approvals** **Declarations of conformity and manufacturer's declarations**



Approval	Standard	Certificate Name
CB DEKRA Certification B.V.	IEC 60998	NL-86543
ENEC 05 DEKRA Certification B.V.	EN 60998	71-127515
KEMA/KEUR DEKRA Certification B.V.	EN 60669	71-101844
UL_Listed_667F Underwriters Laboratories Inc.	UL 486C	E69654
UL Underwriters Laboratories Inc.	UL 467	20180215-E201573

Approval	Standard	Certificate Name
EU-Declaration of Conformity WAGO GmbH & Co. KG	-	-
UK-Declaration of Conformity WAGO GmbH & Co. KG	-	-

**Downloads**

**Environmental Product Compliance**

<b>Compliance Search</b>
Environmental Product Compliance 2773-405

**CAD/CAE-Data**

<b>CAD data</b>
2D/3D Models 2773-405

**1 Compatible Products**

**1.1 Optional Accessories**

**1.1.1 General accessories**

**1.1.1.1 Moisture protection**



**Item No.: 207-1332**  
 Gelbox; Branch; for cables; with gel; 221, 2x73 Series; max. 4 mm<sup>2</sup> connectors; without splicing connectors; Size 2; gray

## 1.1.2 Mounting adapter

### 1.1.2.1 Mounting accessories



**Item No.: 2773-500**

Mounting carrier; for single- and double-row con.; 2773 Series; for DIN-35 rail mounting/screw mounting; orange

## Installation Notes

### Conductor termination



Strip solid or stranded conductor to 13 mm (0.51 inch).

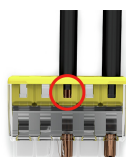

The transparent housing shows if conductors are fully inserted; within the colored base, a clear port shows if the conductor's strip length is correct. Conductors are correctly stripped if the clear port shows no bare conductor on the unprinted connector side. Picture shows center conductor with exceeded strip length.

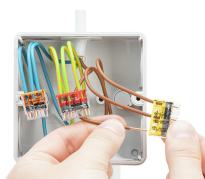

Termination: Insert the stripped conductor until it hits the backstop.

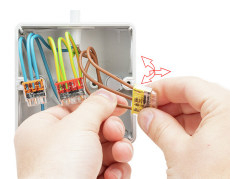

Removal: Hold solid conductor to be removed and twist alternately left and right while pulling the connector.

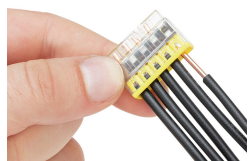

Solid conductors are inserted into the connector by simply pushing them in.



Stranded conductors are inserted into the connector by simply pushing them in.

## Testing



Testing via test port opposite to conductor entry.

## Application

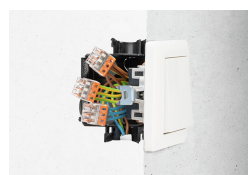

Thanks to their flat and compact design, these connectors are ideal for wiring in flush-mount switch boxes.



With six variants, always have the right connector.